

Matrix-752

Linux-Ready Cortex-A7 Industrial IoT Gateway

Hardware Guide



Version: 1.1
2023 APRIL



Trademarks

The Artila logo is a registered trademark of Artila Inc. All other trademarks or registered marks in this manual belong to their respective manufacturers.

Disclaimer

Information in this document is subject to change without notice and does not represent a commitment on the part of Artila.

Artila provides this document as is, without warranty of any kind, either expressed or implied, including, but not limited to its particular purpose. Artila reserves the right to make improvements and/or changes to this manual, or to the products and/or the programs described in this manual, at any time.

Information provided in this manual is intended to be accurate and reliable. However, Artila assumes no responsibility for its use, or for any infringements on the rights of third parties that may result from its use.

This product might include unintentional technical or typographical errors. Changes are periodically made to the information herein to correct such errors, and these changes are incorporated into new editions of the publication.

FCC AND IC INFORMATION:

This Class A digital apparatus complies with Part 15 of the FCC rules and with Canadian ICES-003

Operation is subject to the following two conditions:

1. This device may not cause interference and
2. This device must accept any interference. Including interference that may cause undesired operation of the device.

Document Amendment History

Revision	Date	Remark
V 1.0	2020 June	Initial
V1.1	2023 April	Linux kernel updated, reset button function updated

Table of Contents

1. Introduction	5
1.1 Features	5
1.2 Specifications (Hardware).....	5
1.3 Specifications (Software).....	7
1.4 Packing List.....	8
1.5 Optional Accessory.....	8
1.6 Optional Communication Module.....	8
2. Layout	9
2.1 Connector & LED Indicator	9
2.2 Dimension	10
3. Pin Assignment and Definitions.....	11
3.1 Multi-function Reset Button.....	11
3.2 LED Indicators.....	12
3.3 Ethernet LAN Port	13
3.4 Power Connector.....	14
3.5 USB OTG Port.....	14
3.6 Serial Port	15
3.7 CAN Bus Port.....	17
3.8 Digital Input	18
3.9 Digital Out	19
3.10 Serial Console Port.....	20
3.11 External Battery connection.....	21
3.12 SD card Socket	21
3.13 miniPCIe Slot.....	22
3.14 Micro-SIM card socket.....	22

1. Introduction

Matrix-752 based on arm Cortex-A7, is a Linux-ready IoT gateway with highly integrated and low power consumption. Matrix-752 provides an ideal building block that easily integrates with a wide range of target markets, such as industrial control, automation, mobile gateway and other applications.

1.1 Features

- NXP iMX6ULL 800MHz Cortex-A7 Processor
- Support Ubuntu / Linux, kernel 5.10.x (or up) and file system
- Support Toolchain: gcc 9.3.0 + glibc 2.31
- 512MB LvDDR3 SDRAM
- Two 10/100Mbps Ethernet port
- One USB OTG port
- One RS-485 / RS-232 port & One RS-232 port
- One CAN port
- Two channels Digital Input
- Two channels Digital out
- One micro-SD socket
- One full size miniPCIe socket inside
- One micro-SIM socket
- Two SMA-type Antenna holes reserved
- +9 to +48VDC power input
- Ultra-low power consumption
- Wall-mounting, Optional DIN RAIL mounting adaptor

1.2 Specifications (Hardware)

CPU / Memory

- CPU: NXP iMX6ULL Cortex-A7 MPCore, up to 800MHz
- SDRAM: 512MB, LvDDR3

Network Interface

- Type: 2 x 10/100Mbps Ethernet
- Connector Type: RJ45 (with LED indicator)

USB Interface

- 1 x USB OTG Port
- Micro-USB connector

TTY (Serial) Ports

- 1 x RS-485 or RS-232 Port
- 1 x RS-232 Port
- Direction Control (RS-485): Auto, by software
- Connector: Terminal block
- RS-485 Signal: Data+, Data-
- RS-232 Signal: TX, RX

TTY (Serial) Port Parameters

- Baud Rate: Up to 921.6Kbps
- Parity: None, Even, Odd, Mark, Space
- Data Bits: 5, 6, 7, 8
- Stop Bits: 1, 1.5, 2
- Flow Control: RTS / CTS, XON / XOFF, None

CAN Bus Ports

- 1 x CAN Bus 2.0 A/B compliant ports
- Speed: Up to 1Mbps
- Isolation: 2500Vrms

Digital Input

- 2 x Digital Input Channels
- Isolation Protection: 2500Vrms (Photo Coupler)
- Logical High: 5~24VDC
- Logical Low: 0~1.5VDC

Digital Output

- 2 x Digital Output Channels (Solid State Relay)
- Solid State Relay: Normal Open (NO) Type
- Contact Rating: 80VDC@1.5A

Console / Debug Ports

- Serial console port
- 4PIN Box header (inside the box)

SD Slot

- 1 x microSD socket
- SD 2.0 compliant, supports SDHC
- Storage capacity: Support up to 128G

Expansion Slot

- 1 x Full-Size miniPCIe socket
- 1 x micro-SIM card socket reserved, USB interface
- 2 x SMA-type Antenna holes reserved

Power Requirement

- Input Voltage: +9~+48VDC (terminal block)
- Typical Power Consumption: 12VDC@250mA
(miniPCIe module, SD card are not included)

General

- Watchdog: Yes
- Realtime Clock: Yes, backup by super capacitor
- Dimensions (W x L x H): 89 x 112 x 30mm (3.5 x 4.4 x 1.18in)
- Net Weight: 350g (0.77lb), miniPCIe module and antenna are NOT included.
- Operating Temperature: 0~70°C (32~158°F)
- Regulation: CE Class A, FCC Class A
- Installation: Wall mounting, DIN-rail mounting (with optional kit)

1.3 Specifications (Software)**Operation System**

- Support Ubuntu / Linux, kernel 5.10.x (or up)
- Supports bootup from eMMC or SD card
- Support Backup/Restore from SD card or USB device
- Boot Loader: U-Boot
- File System: EXT4/EXT3/EXT2, VFAT/FAT, NFS

Software Development

- Toolchain: gcc 9.3.x + glibc 2.31
- Supports in-place C/C++ code compilation

Package Management

- Package repository: Artila self-maintained repository
- Command: Using standard apt-get command

Popular Packages

- Web server: Apache/Nginx/Lighttpd
- Database: MySQL/SQLite3/PostgreSQL
- Script Language: PHP/Python/Perl/NodeJS
- Text editor: vim/nano/sed
- Administration: Webmin

1.4 Packing List

- **Matrix-752:** Linux-ready Cortex-A7 800MHz Industrial IoT Gateway with 512MB SDRAM, 16G eMMC

1.5 Optional Accessory

- **DK-35A** (36-DK35A-000): DIN RAIL Mounting Kit
- **PWR-12V-1A:** 110~240VAC to 12VDC 1A Power Adaptor
- **Console Cable** (CB-PHDF9-050): 4Pin Wafer Box to DB9 Female, 50cm

1.6 Optional Communication Module

- 4G/LTE miniPCIe Module with Antenna
- Wifi miniPCIe Module with Antenna

2. Layout

2.1 Connector & LED Indicator

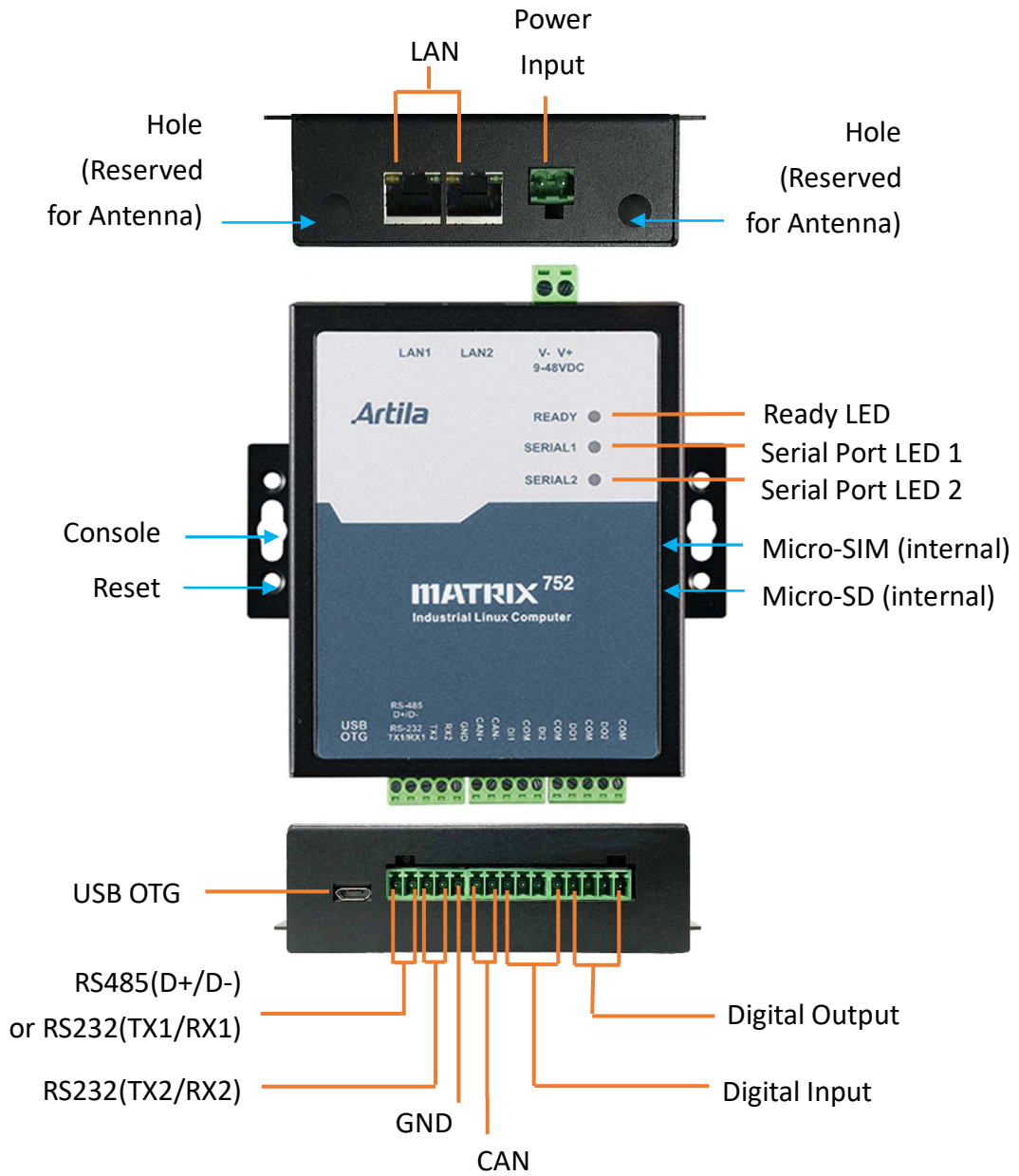

3. Pin Assignment and Definitions

3.1 Multi-function Reset Button

The Matrix-752 provides a multi-function reset button located on the side of the chassis as shown below:



The behavior of the reset button depends on how long you press the reset button.

Press and hold the reset button	Behavior	Network settings after reboot
< 3 seconds then release	Re-boot the Matrix-752	Retains last user settings
3~10 seconds then release	Reset the network setting (The same setting as factory default)	eth0 IP: addr. by DHCP eth1 IP: IP192.168.2.127
> 10 seconds then release	Restore and back to factory default. User's data may disappear	eth0 IP: addr. by DHCP eth1 IP: IP192.168.2.127

3.3 Ethernet LAN Port

There are two 10/100Mbps Ethernet by RJ45 (with LED indicator) connectors.



The Ethernet Port use RJ45 connector. Pin-Assignment as below:

PIN	Signal
1	ETx +
2	ETx -
3	ERx +
6	ERx -

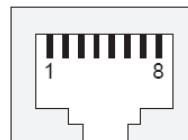

3.6 Serial Port

The Matrix-752 has two serial ports:

- One RS-485/RS-232 ports, Default setting is RS-485.
- One RS-232 port (TX/RX)

RS-485 is designed without isolation that automatically direction controlled via software

The pin assignment is shown as following table:

Port No.		Pin1	Pin2		Pin3	Pin4	Pin5
Serial Port 1	RS-485	D+	D-		--	--	GND
	RS-232 (1)	TX1	RX1		--	--	GND
Serial Port 2	RS-232 (2)	--	--		TX2	RX2	GND

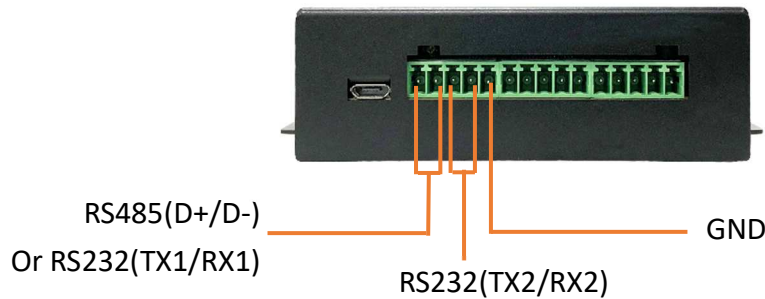

Enable/Disable Termination resistor for RS-485 (JP4)

The Matrix-752 provides on-board 120Ohm termination resistor for each RS-485 port. To enable the termination resistor, please remove the upper cover of the Matrix-752, and the adjust the associated jumper to short as below:

Termination Resistor Disabled (default)	<p>1 2 3</p>
Termination Resistor Enabled	<p>1 2 3</p>

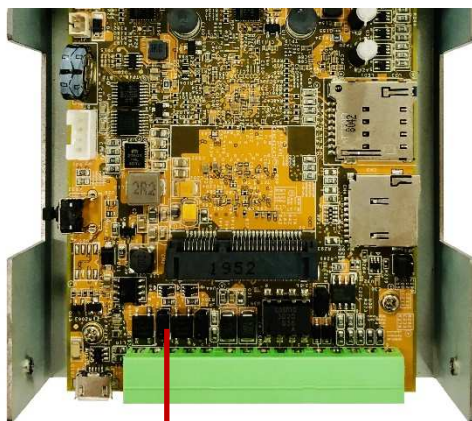

JP4

Set Serial Port 1 to RS232 port (JP3 & JP6)

The Serial Port on Matrix-752, default is RS-485 at JP3 (setting Pin 3 and Pin4)

To Enable RS-232 port, setting JP3 at Pin 1 and Pin 2

RS-485 (default)	
RS-232	

In the meantime, it should set D+/TX1 definition at JP6.

Default setting is for RS-485 (D+) at JP6/Pin 2 and Pin 3.

To Enable RS232 / TX1, setting JP6 at Pin 1 and Pin 2

TX1 (Pin1 definition) for RS-485 (default)	
TX1 (Pin1 definition) for RS-232	

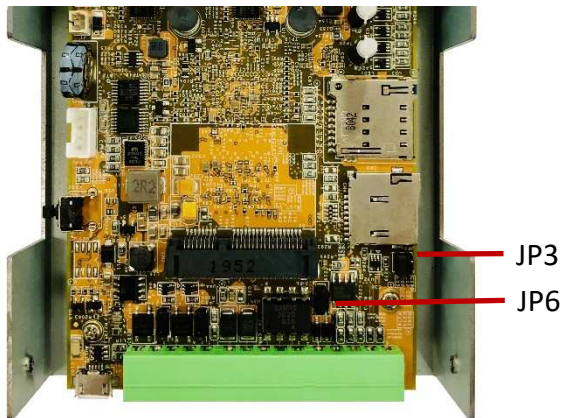

3.7 CAN Bus Port

The Matrix-752 comes with one CAN bus ports.

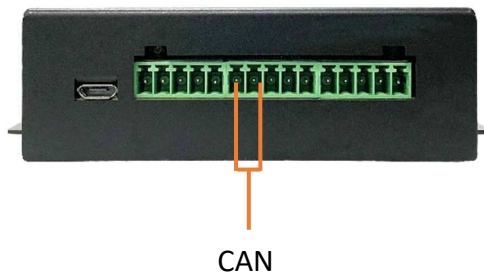

Users can open the CAN bus port as network sockets, the socket names are 'can0'

Port Label.	CAN
Socket Mapping	can0

Pin assignment of CAN Bus Port

Pin	Pin6	Pin7
Signal	CAN_Hi (CAN+)	CAN_Lo (CAN-)

Enable/Disable Termination resistor for CAN bus (JP5)

The Matrix-752 provides on-board 120Ohm termination resistor for each CAN port.

Default setting is "Disable" the terminal resistor for CAN bus.

To enable the termination resistor, please remove the upper cover of the Matrix-752, and the adjust the associated jumper to short position1 and position 2, shown below:

Termination Resistor Disabled (Default)	 1 2 3
Termination Resistor Enabled	 1 2 3

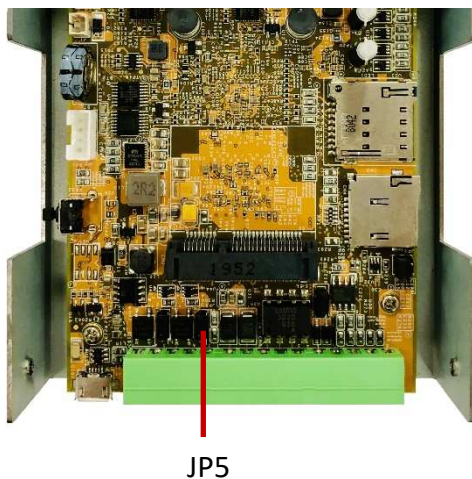

3.8 Digital Input

Two channels Digital Input are equipped with 5000Vrms photocoupler isolation which share the same common ground.

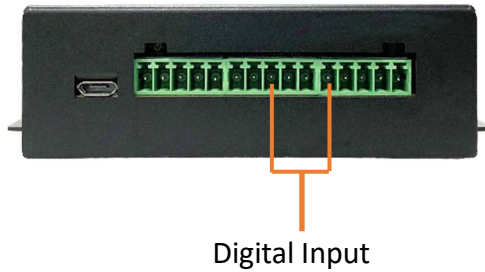

Pin assignment of Digital Input

Pin	Pin8	Pin9	Pin10	Pin11
Signal	DI1	COM	DI2	COM

The specification of the isolated input channels is:

Logical High: 5~24Vdc

Logical Low: 0~1.5Vdc

Input resistance: 1.8KOhms@0.32W

Response time: 20μs

Isolation: 5000Vrms

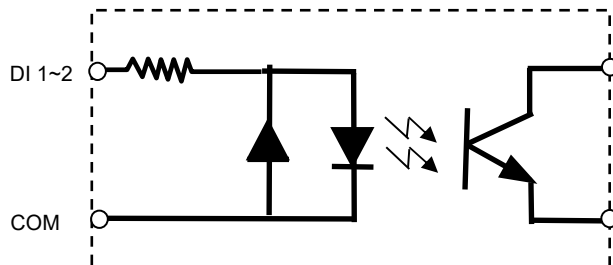

DIx: Isolated digital input channels.

COM: Common ground.

3.9 Digital Out

There are two channels Digital Output by solid state relay.

- Solid State Relay: Normal Open (NO) Type
- Contact Rating: 80VDC@1.5A

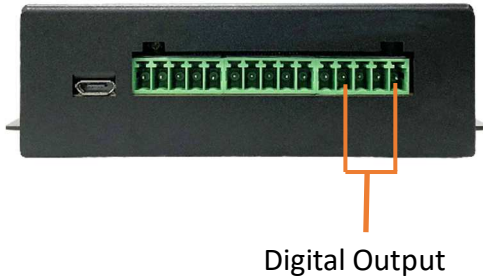

Pin assignment of Digital Input

Pin	Pin12	Pin13	Pin14	Pin15
Signal	DO1	COM	DO2	COM

Reference Circuit as following:

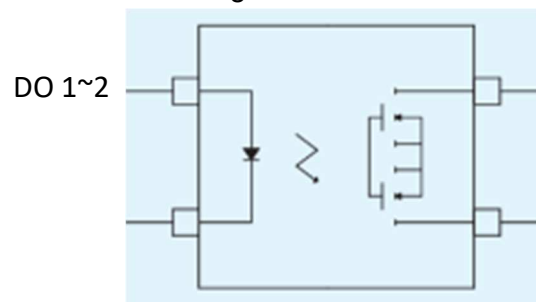

3.10 Serial Console Port

There is a 4-pin wafer box header (JP2) inside the Matrix-752 features as serial console port that used for locally accessing Matrix-752 system via console port.

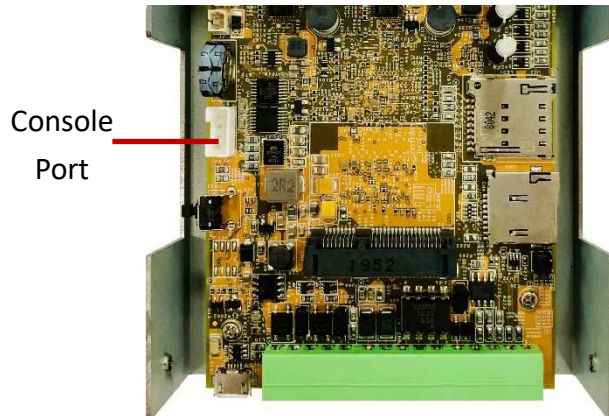

Pin assignment is: RX, TX, +3.3V, GND.

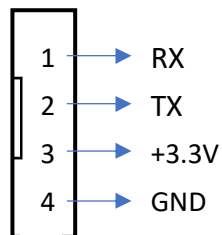

Therefore, you need to open the upper metal case and prepare or purchase a serial console cable to use the serial console port.

Or, it can be purchased “Console Cable” from Artila, P/N is [CB-PHDF9-050](#).



3.11 External Battery connection

There is a 2Pin wafer (1.2mm pitch) reserved that can be connected to external battery for RTC

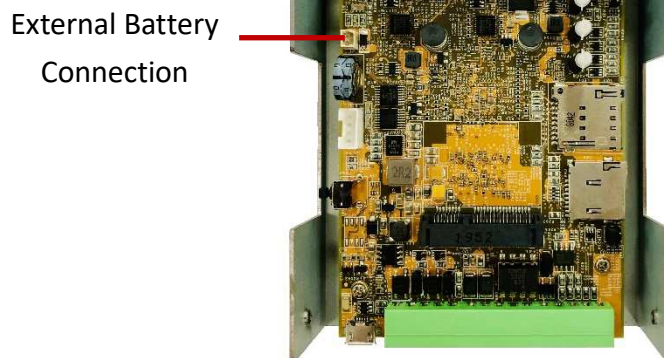

3.12 SD card Socket

There is a micro-SD card socket inside as data storage.
After removed top cover, it can be accessed the SD card.

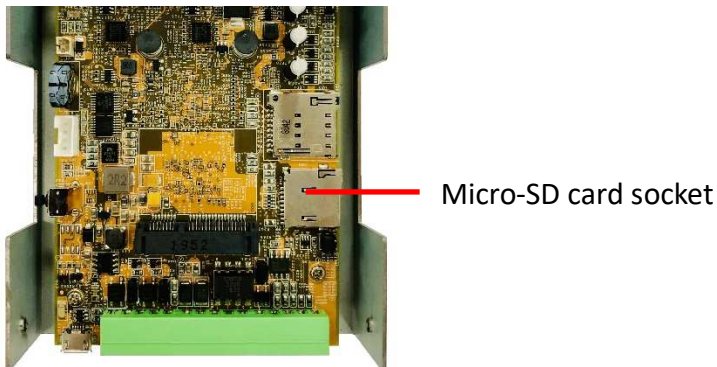

3.13 miniPCle Slot

The Matrix-752 comes with a miniPCle slot and dual holes for antenna reserved for communication/networking functionality.

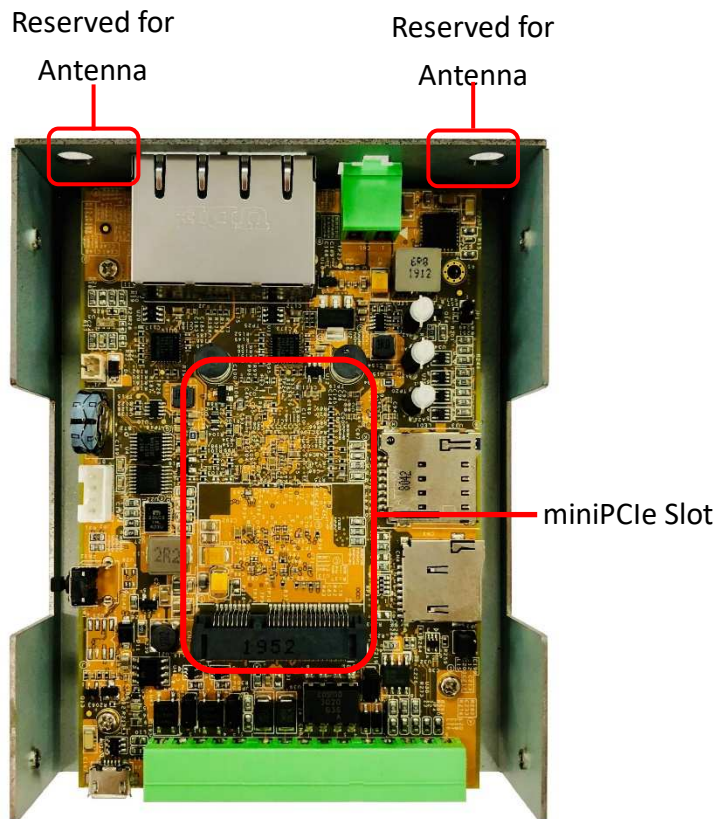

3.14 Micro-SIM card socket

There is a micro-SIM card socket inside.

After removed top cover, it can be inserted a micro-SIM card accompanying LTE/4G module.

